

PROMOTIONAL DISPLAYS



KKGPromotions.com

PINWHEEL PALLET | OPEN TOP

Size: can vary

- Open top provides full visibility to product
- Can be designed with or without shelf lips
- Graphic panels on all four sides

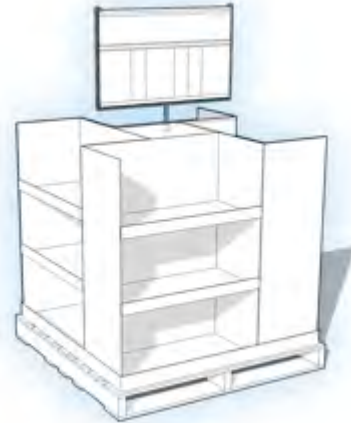

PINWHEEL PALLET | SQUARE HEADER

Size: can vary

- Open top provides full visibility to product
- Can be designed with or without shelf lips
- Graphic panels on all four sides

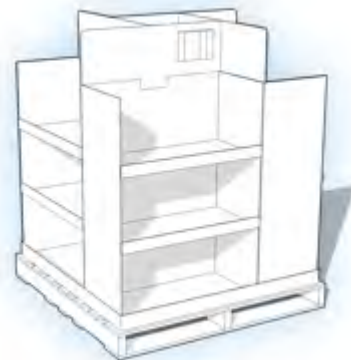

PINWHEEL PALLET | CUSTOM HEADER

Size: can vary

- Open top provides full visibility to product
- Can be designed with or without shelf lips
- Graphic panels on all four sides

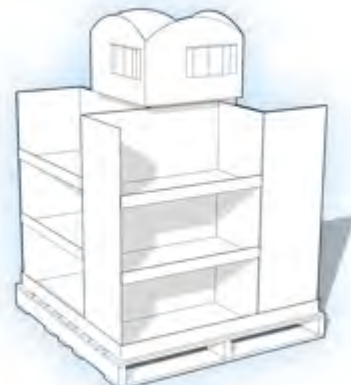

PINWHEEL PALLET | CUTBACK TOP

Size: can vary

- Cutback top provides greater visibility to product
- Can be designed with or without shelf lips
- Graphic panels on all four sides

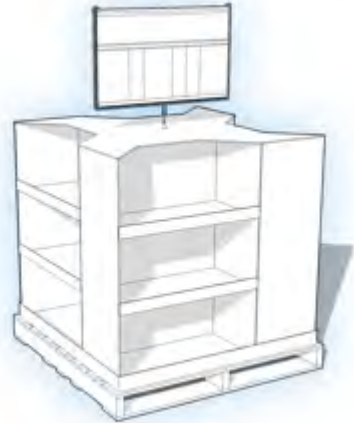

PINWHEEL PALLET | SQUARE HEADER

Size: can vary

- Cutback top provides greater visibility to product
- Can be designed with or without shelf lips
- Graphic panels on all four sides



PINWHEEL PALLET | CUSTOM HEADER

Size: can vary

- Cutback top provides greater visibility to product
- Can be designed with or without shelf lips
- Graphic panels on all four sides

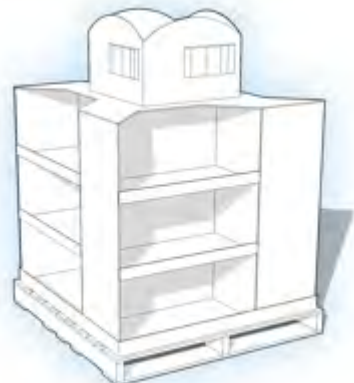

PINWHEEL PALLET | WITH TOP CAP

Size: can vary

- Can be designed with or without shelf lips
- Graphic panels on all four sides



PINWHEEL PALLET | SQUARE HEADER

Size: can vary

- Can be designed with or without shelf lips
- Graphic panels on all four sides



PINWHEEL PALLET | CUSTOM HEADER

Size: can vary

- Can be designed with or without shelf lips
- Graphic panels on all four sides



BACK TO BACK PALLET

Size: can vary

- The number of shelves & cubbies can vary
- Graphic panels on each end

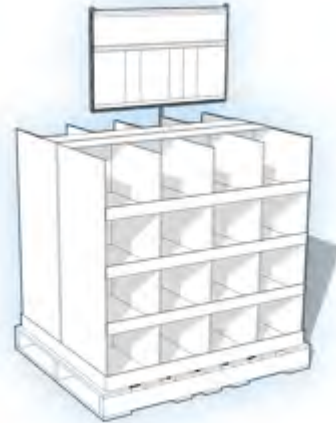

BACK TO BACK PALLET | SQUARE HEADER

Size: can vary

- The number of shelves & cubbies can vary
- Graphic panels on each end

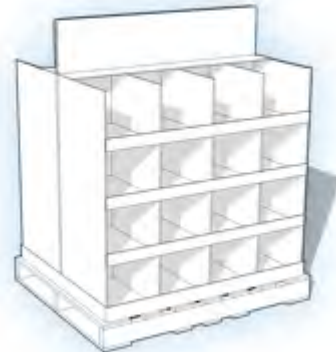

BACK TO BACK PALLET | CUSTOM HEADER

Size: can vary

- The number of shelves & cubbies can vary
- Graphic panels on each end



HALF PALLET | OPEN TOP

Size: can vary

- The number of shelves & cubbies can vary
- Graphic panels on each end
- Shops from one side



HALF PALLET | SQUARE HEADER

Size: can vary

- The number of shelves & cubbies can vary
- Graphic panels on each end
- Shops from one side



HALF PALLET | CUSTOM HEADER

Size: can vary

- The number of shelves & cubbies can vary
- Graphic panels on each end
- Shops from one side



HALF PALLET | OPEN TOP

Size: can vary

- The number of shelves & cubbies can vary
- Graphic panels on front
- Shops from three sides



HALF PALLET | SQUARE HEADER

Size: can vary

- The number of shelves & cubbies can vary
- Graphic panels on front
- Shops from three sides

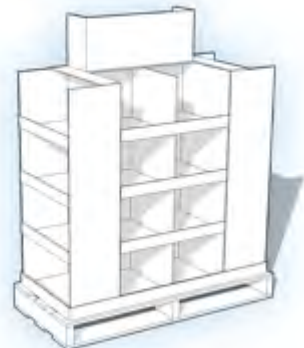

HALF PALLET | CUSTOM HEADER

Size: can vary

- The number of shelves & cubbies can vary
- Graphic panels on front
- Shops from three sides



HALF PALLET | CUT BACK TOP

Size: can vary

- The number of shelves & cubbies can vary
- Graphic panels on front
- Shops from three sides



HALF PALLET | SQUARE HEADER

Size: can vary

- The number of shelves & cubbies can vary
- Graphic panels on front
- Shops from three sides



HALF PALLET | CUSTOM HEADER

Size: can vary

- The number of shelves & cubbies can vary
- Graphic panels on front
- Shops from three sides



HALF PALLET | TOP CAP

Size: can vary

- The number of shelves & cubbies can vary
- Graphic panels on front
- Shops from three sides

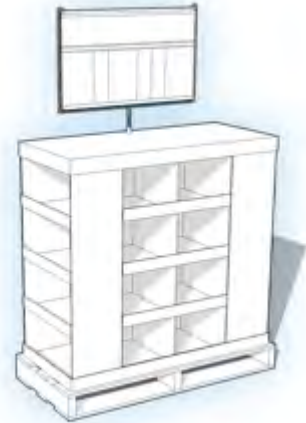

HALF PALLET | SQUARE HEADER

Size: can vary

- The number of shelves & cubbies can vary
- Graphic panels on front
- Shops from three sides



HALF PALLET | CUSTOM HEADER

Size: can vary

- The number of shelves & cubbies can vary
- Graphic panels on front
- Shops from three sides



CLIPPED CORNER PALLET

Size: can vary

- Open top provides full visibility to product
- The number of shelves & cubbies can vary
- Graphic panels on four corners
- Shops from four sides

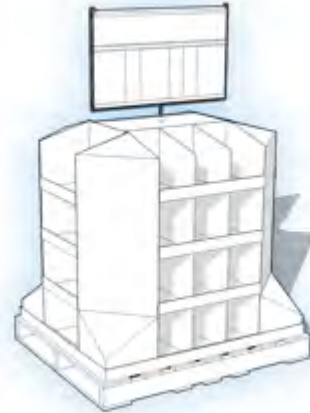

CLIPPED CORNER PALLET | SQUARE HEADER

Size: can vary

- Open top provides full visibility to product
- The number of shelves & cubbies can vary
- Graphic panels on four corners
- Shops from four sides



CLIPPED CORNER PALLET | CUSTOM HEADER

Size: can vary

- Open top provides full visibility to product
- The number of shelves & cubbies can vary
- Graphic panels on four corners
- Shops from four sides

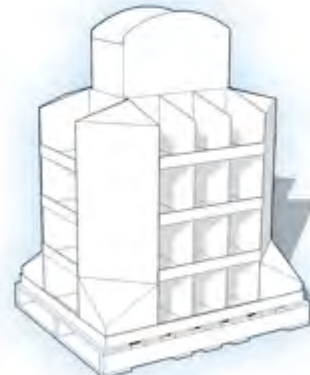

CLIPPED CORNER PALLET

Size: can vary

- Cut back top provides greater visibility to product
- The number of shelves & cubbies can vary
- Graphic panels on four corners
- Shops from four sides



CLIPPED CORNER PALLET | SQUARE HEADER

Size: can vary

- Cut back top provides greater visibility to product
- The number of shelves & cubbies can vary
- Graphic panels on four corners
- Shops from four sides



CLIPPED CORNER PALLET | CUSTOM HEADER

Size: can vary

- Cut back top provides greater visibility to product
- The number of shelves & cubbies can vary
- Graphic panels on four corners
- Shops from four sides



CLIPPED CORNER PALLET

Size: can vary

- The number of shelves & cubbies can vary
- Graphic panels on four corners
- Shops from four sides

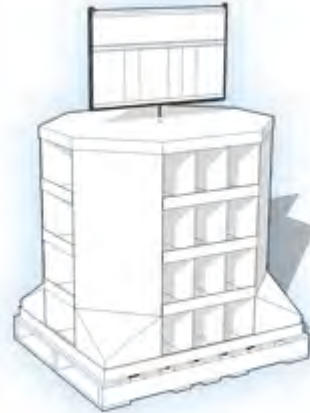

CLIPPED CORNER PALLET | SQUARE HEADER

Size: can vary

- The number of shelves & cubbies can vary
- Graphic panels on four corners
- Shops from four sides



CLIPPED CORNER PALLET | CUSTOM HEADER

Size: can vary

- The number of shelves & cubbies can vary
- Graphic panels on four corners
- Shops from four sides



PALLET DUMP BIN

Size: 48" x 48" x variable height

- Perfect for promotional products

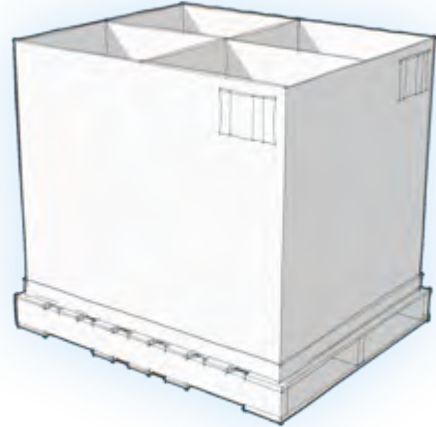

HALF PALLET DUMP BIN

Size: 24" x 48" x variable height

- Perfect for promotional products

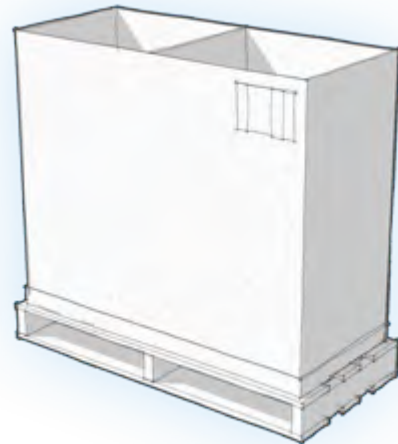

QUARTER PALLET DUMP BIN

Size: 24" x 24" x variable height

- Perfect for promotional products



STACKOUT ARCH TOP HEADER

Size: can vary

- Add as a header on a stackout pallet
- Shape across top can vary



STACKOUT STANDARD HEADER

Size: can vary

- Add as a header on a stackout pallet



STACKOUT TENT HEADER

Size: can vary

- Add as a header on a stackout pallet



ENDCAP AWNING

Size can vary

- Provides a large header to increase the visual presence of product featured on an endcap

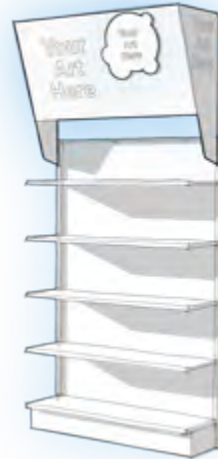

ENDCAP BLADES | DIE CUT

Size can vary

- Adds messaging / graphic space on each side of an endcap
- The shape can be die cut as needed to match the required graphics



ENDCAP BLADES

Size can vary

- Adds messaging / graphic space on each side of an endcap



BOX TOPPER SHIRT TAIL

Size: can vary

- Provides a graphic space on the back of a hardline fixture in addition to what is visible on the front



BOX TOPPER

Size: can vary

- Expand your messaging space over the top of a hardline fixture



NEIGHBORHOOD MARKET BOX TOPPER

Size: can vary

- Expand your messaging space over a Neighborhood Market endcap



INSERTS

Size: based on fixture type

- Customize your message on a hardline or softline fixture

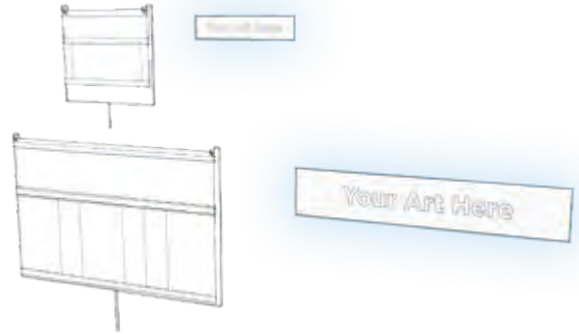

GRAPHIC PANELS

Size: based on fixture type

- Customize a large message on a hardline or softline fixture



DIE CUT INSERTS

Size: can vary based on fixture type

- Customize your message on a hardline or softline fixture



SIDE SLIDES

Size: can vary based on fixture type

- Add a message to the standard hardline or softline fixture
- Affixes to the side of the upper channel on the fixture

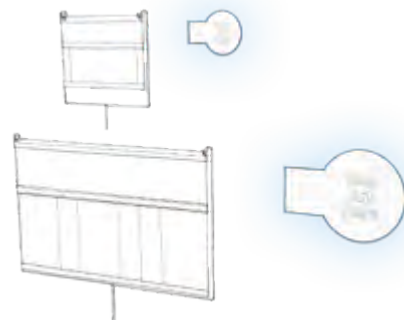

APPAREL FOUR-WAY HEADER

Size: can vary

- Provide a branded header over the top of an apparel four-way fixture



FOUR-WAY FIXTURE DRESSOUT

- Various elements can be utilized for graphic messaging and information on a four-way fixture



PARK-A-PALLET

Size: 22" x 53.5" x 48" high (plus sign)

- Full or half pallets can be placed underneath
- Large side panel graphics
- Shelf overhead for cross-merchandising
- Ships KDF
- Brochure holders can be added
- **Approved for use in Walmart**

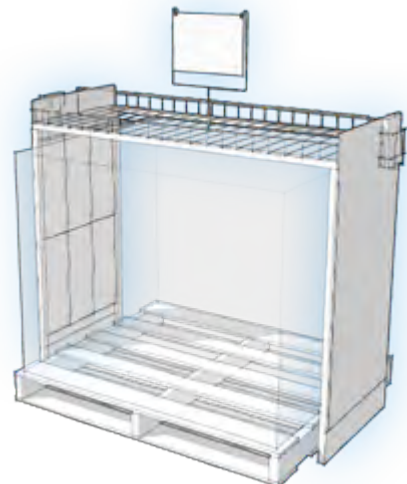

PRODUCT CARDS | CLUB PALLETS

Size: can vary

- Often used in Clubs when product inventory is held in a secure location at the front of store



STACKABLE TRAYS | SMALL

Size: can vary

- Product trays stack to create a full pallet display



STACKABLE TRAYS | LARGE

Size can vary

- Product trays stack to create a full pallet display



“L” PALLET PANEL

Size: can vary

- Great for adding graphics to a pallet display

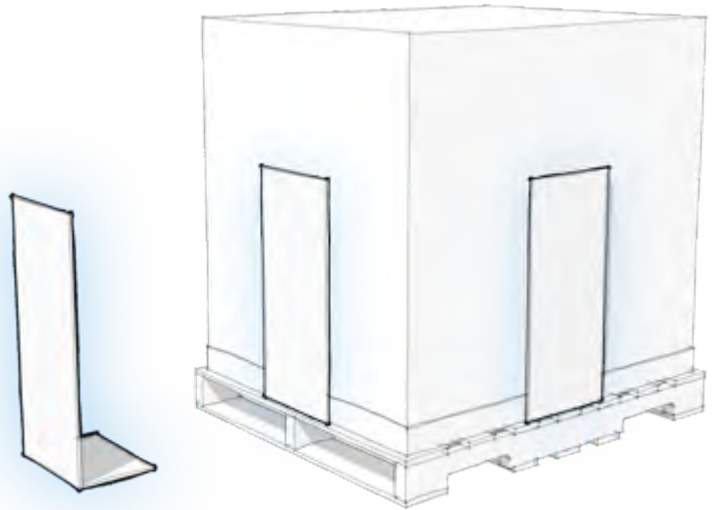

PALLET SKIRT

Size: can vary

- Provides large side panels for graphics
- **Approved for use in Clubs**

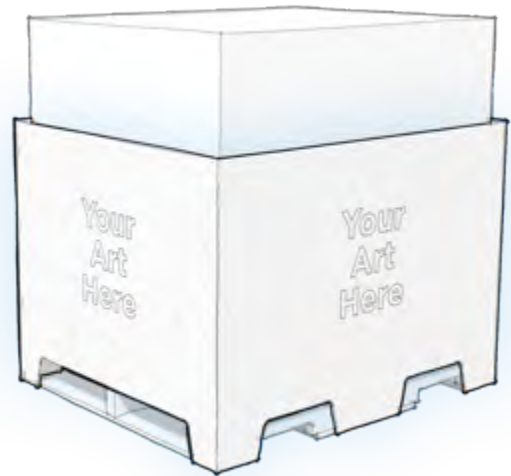

PALLET BASE WRAP

Size can vary

- Easily add graphic messaging to the base of a pallet display
- Wraps around the full pallet

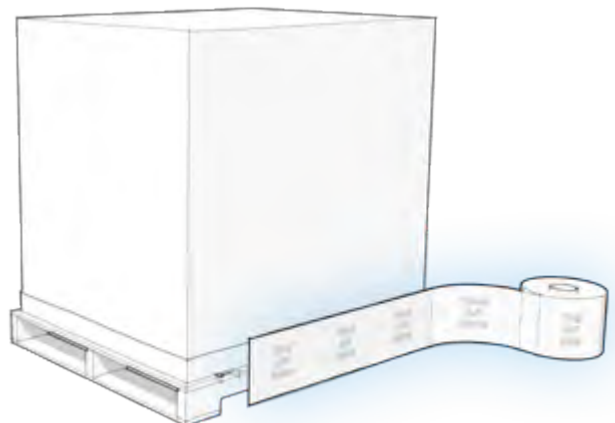

PILLOW BOX FLOORSTAND

Size: 22" x 16" x 66" high (can be modified)

- Clean visual presence at retail
- Large graphic / messaging space on two sides
- Eye-catching shape
- Easy set-up



MONOLITH

Size: 24" x 16" x 66" high (can be modified)

- Clean visual presence at retail
- Large graphic / messaging space on two sides
- Time proven design
- Easy set-up



TRIANGLE FLOORSTAND

Size: 17"w (ea. face) x 62" high (can be modified)

- Clean visual presence at retail
- Graphic / messaging space on three faces
- Straightforward shape and design
- Easy set-up



PILLOW BOX FLOORSTAND WITH PEGHOOKS

Size: 22" x 16" x 66" high (can be modified)

- Clean visual presence at retail
- Large graphic / messaging space on two sides
- Eye-catching shape
- Easy set-up
- Peghooks provide merchandising opportunities



MONOLITH WITH PEGHOOKS

Size: 24" x 16" x 66" high (can be modified)

- Clean visual presence at retail
- Large graphic / messaging space on two sides
- Time proven design
- Easy set-up
- Peghooks provide merchandising opportunities

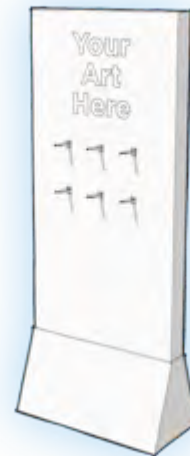

TRIANGLE FLOORSTAND WITH PEGHOOKS

Size: 17" w (ea. face) x 62" high (can be modified)

- Clean visual presence at retail
- Graphic / messaging space on three faces
- Straightforward shape and design
- Easy set-up
- Peghooks provide merchandising opportunities

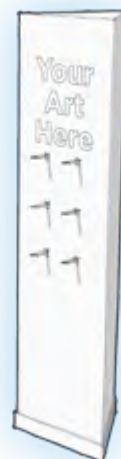

PILLOW BOX FLOORSTAND WITH POCKETS

Size: 22" x 16" x 66" high (can be modified)

- Clean visual presence at retail
- Pockets can be added for gift cards or similar items
- Eye-catching shape
- Easy set-up



MONOLITH WITH POCKETS

Size: 24" x 16" x 66" high (can be modified)

- Clean visual presence at retail
- Pockets can be added for gift cards or similar items
- Time proven design
- Easy set-up



OBELISK WITH POCKETS

Size: 18" x 14" x 68" high (can be modified)

- Clean visual presence at retail
- Pockets can be added for gift cards or similar items
- Unique angled shape and design
- Easy set-up



PILLOW BOX TIRE FEATURE

Size: 22" x 12" x 66" high

- Unique design for tire feature or promotion
- Visually appealing design
- Easy set-up
- Two-sided



MONOLITH TIRE FEATURE

Size: 29" x 14" x 63" high

- Perfect for tire feature or promotion
- Large space for graphic / messaging opportunity
- Easy set-up



NARROW MONOLITH TIRE FEATURE

Size: 16" x 24" x 60" high

- Compact design for tire feature or promotion
- Easy set-up



PILLOW BOX SHOE DISPLAY

Size: 22" x 16" x 66" high (can be modified)

- Clean visual presence at retail
- Shelves can be used for shoe display feature or promotion
- Eye-catching shape
- Easy set-up
- Two-sided



MONOLITH SHOE DISPLAY

Size: 24" x 16" x 66" high (can be modified)

- Clean visual presence at retail
- Shelves can be used for shoe display feature or promotion
- Time proven design
- Easy set-up
- Two-sided



PALLET STACKOUT GRAPHIC

Size: 12" x 12" x variable height

- Simple design for signing a stackout display
- Graphic panel at top can vary in size and shape
- Easy set-up



SADDLEBAG FIXTURE DRESSOUT

- Graphic dressout of Walmart fixture
- Side panels, shelf strips, header, etc.



CUBE STACK

Size can vary

- Small footprint
- Excellent vehicle for graphics & messaging
- Interesting shape
- Ships flat and easy to set up at store



MODULAR MONOLITH

Size can vary

- Simple design creates this monolith
- Terrific for graphics and messaging
- Individual components ship economically
- Easy set-up



PIZZA BOX STANDEE

Size: can vary

- Strong visual presence in-store
- Perfect for multiple images or messages
- Breaks down for easy shipping
- Easy set-up

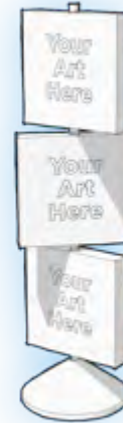

RECYCLE / TRASH BIN

- Environmentally friendly option
- Graphics can be tailored as appropriate



STACKOUT SHROUD

Size: can vary

- Provides a method to add graphics to a simple product stackout
- Optional header is also available



BACKER PAPER

Size can vary

- Covers the pegboard on a gondola fixture

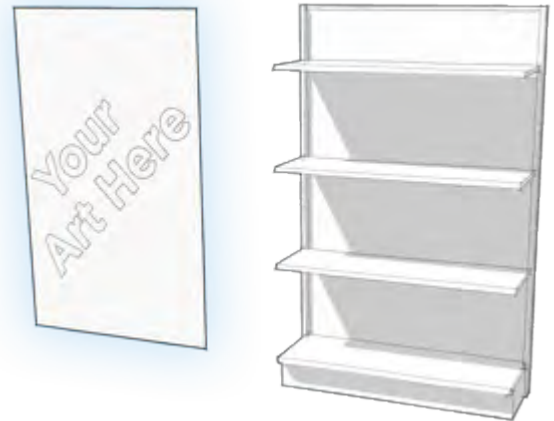

PDQ TRAYS

Size and styles can vary

- Convenient trays for easily merchandising product in-store
- Configurations can be customized to match the needs for a given product or project

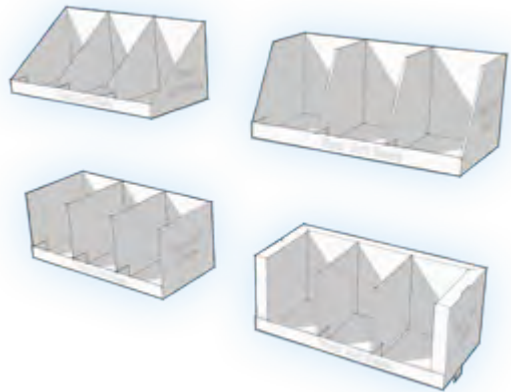

SIDEKICKS

Size and styles can vary

- Great for cross merchandising product in various areas of the retail environment
- Configurations can be customized to match the needs for a given product or project



SEMI-PERMANENT GIFT CARD DISPLAY

Size can vary

- Can be customized in size, shape and configuration to align with specific program requirements



GIFT CARD SPINNER DISPLAY

Size can vary

- Small footprint
- Shops from all sides
- Nice graphic space on the header
- Powder coated wire construction



GIFT CARD SIDEKICK

Size can vary

- Great for promotional programs
- Easy to use in various departments across a retail environment



GIFT CARD MINI SIDEKICK DISPLAY

Size can vary

- Can be customized in size, shape, color and configuration to align with specific program requirements
- Vacuum formed plastic construction makes the unit durable for longer shelf life



GIFT CARD SHELF TALKER

Size can vary

- Easily affixes to shelf
- Can be used for targeted placement at shelf
- Powder coated metal construction

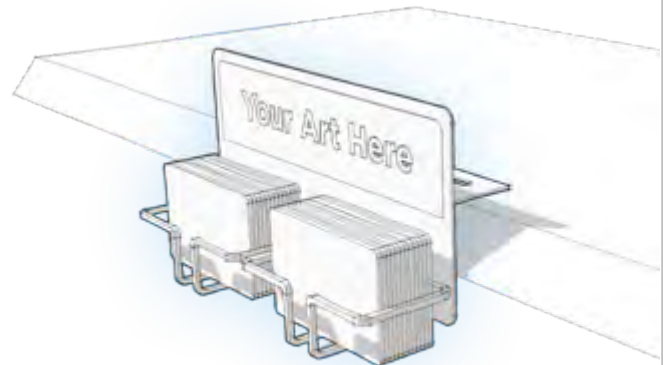

GIFT CARD WIRE POCKET

Size can vary

- Affixes to wire sidekick units

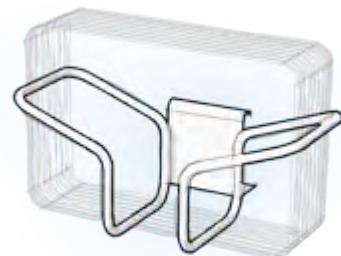

AISLE VIOLATORS / BLADES

Size: can vary

- Grab attention down an aisle
- Sizes and shapes can adjust as appropriate
- Easy to install

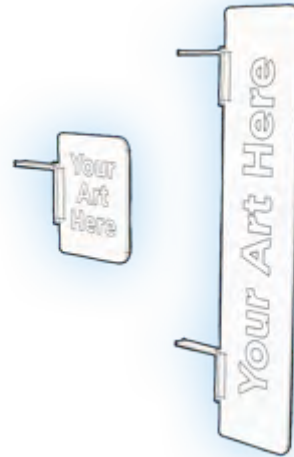

FLIP BOOKS

Size: can vary

- Places information and education directly at the point of purchase
- Can be customized based upon individual need

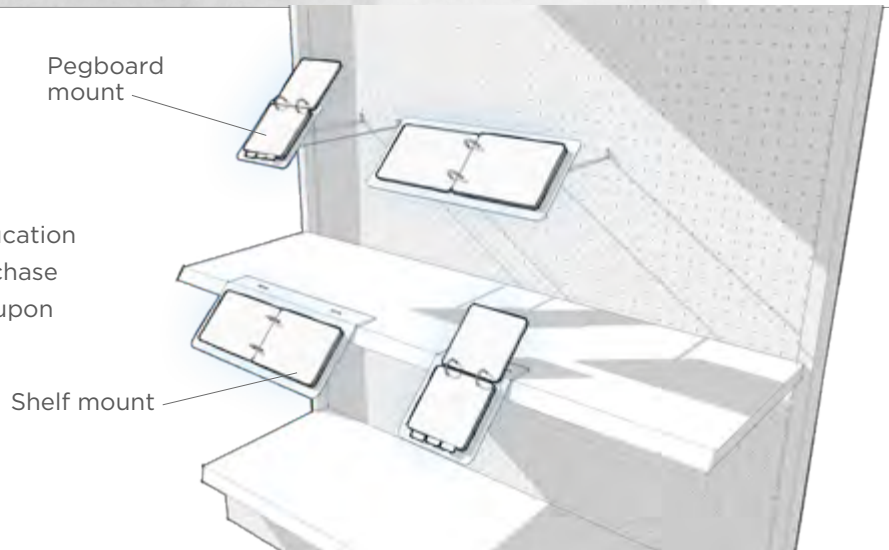

BEAN FLIPS / WOBBLERS

Size: can vary

- Serves to grab attention at shelf
- Size and shape can vary as needed
- Easy to install



STREET TALKER

Size: 24" x 24" x 44" high

- Low profile sign for messaging outdoors
- Moves with the wind to maintain stability
- Durable material to withstand the weather
- Two-sided



TIRE SLEEVE

Size: can vary

- Promotional piece for tires
- Durable vinyl for use inside or outside



BOLLARD SLEEVE

Size: 7.5" x 7.5" x 56" high

- Slips over "bollards" in front of stores
- Coroplast material is durable in the weather
- Provides incremental messaging space directly outside the store entrance



FEATHER BANNER

Size: can vary

- Customize your graphics for a unique look
- Grab attention as it moves in the wind



COROPLAST BANNER

Size: can vary

- Use as a graphic or information panel
- Grommets allow for easy attachment
- Durable for use inside or outside

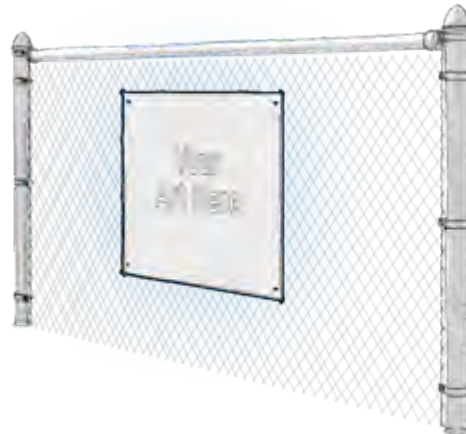

VINYL BANNER

Size: can vary

- Use as a graphic or information panel
- Grommets allow for easy attachment
- Can be used inside or outside
- Rolls up for easy shipping



CLIP STRIPS

Size: can vary

- Ideal for impulse product merchandising throughout the store



EASEL BACK SIGNS

Size: can vary

- Great for messaging on a counter or shelf



COUPON PADS

Size: can vary

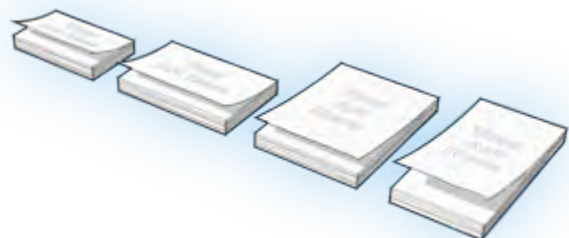

PIN BUTTONS

Various sizes are available



COUNTER MAT

Various sizes are available



FLOOR GRAPHICS

Various sizes are available

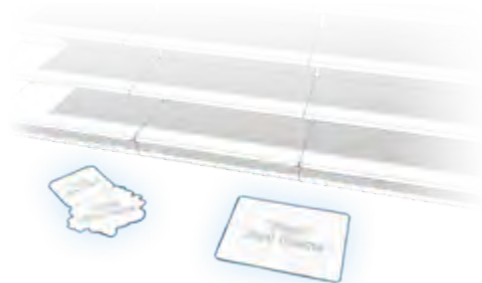

TABLECLOTHS

Various sizes are available



BADGE BACKERS

Size: can vary

- Share your message on the nametags of Walmart associates



ALUMINUM TABLE TENT

Size: 4.5" x 2.25" x 7" high

- Aluminum construction for durability
- Graphics can include space for dry-erase marker messages



COUNTERTOP PILLOW BOX

Size: can vary

- Eye catching shape
- Share your message in a small unit
- Two sided
- Easy set-up

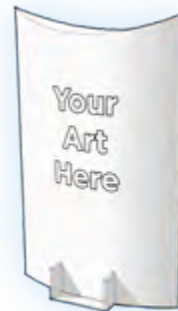

CHECKOUT SIGN

Size: can vary

- Share your message over each checkout lane
- Easy to install



MYLAR BALLOONS

Various sizes are available



INFORMATION BOX

Various sizes are available

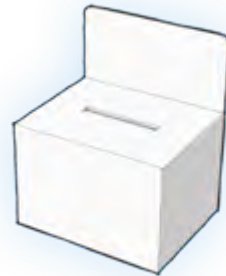

MAGNETIC SIGNS

Various sizes are available



OUTDOOR / YARD SIGN

Various sizes are available



SHELF STRIPS

Size: 1.25" X 48"

- Add your message to front of shelf

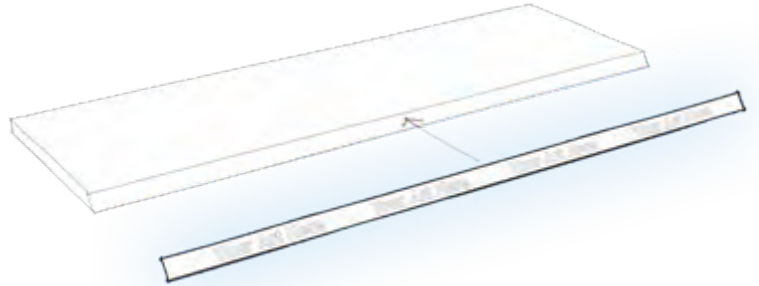

WINDOW CLINGS

Size: can vary

- Share your message directly at the point of purchase in the dairy or freezer section
- Shapes and sizes can vary based on your artwork and message
- Easy to install

